

**PRESSURE PLATE**  
(MOVABLE)  
SECTION A-A  
PP = 20

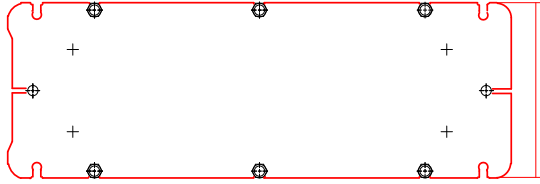

TEST PRESSURE  
DESIGN PRESSURE  
MAX TEMPERATURE  
MIN TEMPERATURE  
GASKET  
PLATE MATERIAL  
PLATE THICKNESS  
HEAT LOAD

	SIDE 1	SIDE 2
TEST PRESSURE	13.0 bar	13.0 bar
DESIGN PRESSURE	10.0 bar	10.0 bar
MAX TEMPERATURE	85.0 °C	80.0 °C
MIN TEMPERATURE	0.0 °C	0.0 °C
GASKET	NBRP Clip-on	
PLATE MATERIAL	ALLOY 304	
PLATE THICKNESS	0.50 mm	
HEAT LOAD	100.0 kW	

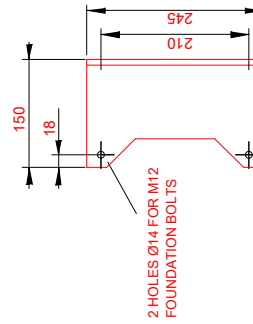
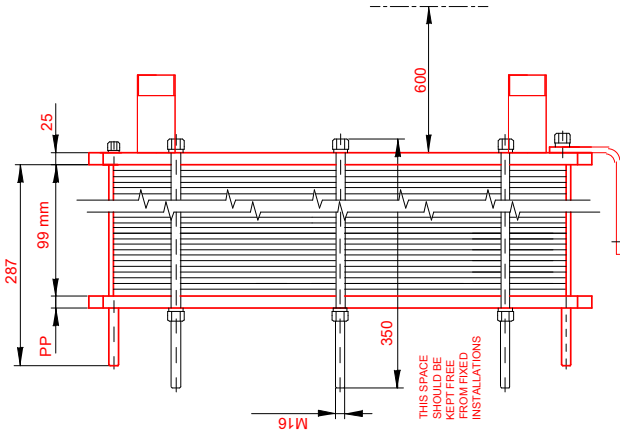

**FRAME PLATE**  
(FIXED)

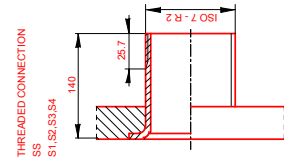
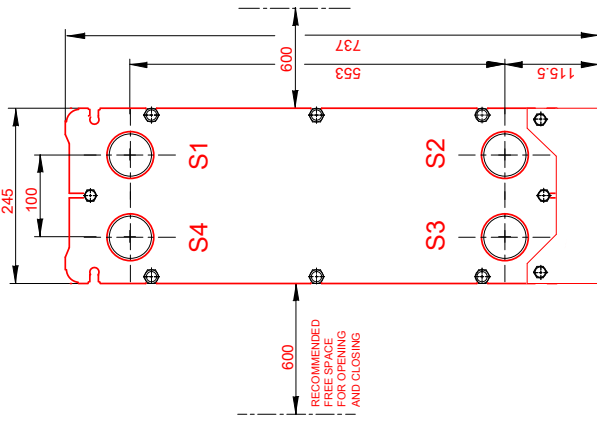

ALL DIMENSIONS IN MILLIMETERS Do not use this drawing for foundation bolting or piping layout.

SIDE	MEDIA	F.D.G.	INLET	TEMP.	OUTLET	TEMP.	FLOW RATE	PRESSURE DROP
1	Water	2	S1	82.0 °C	S2	71.0 °C	8.07 m³/h	29.1 kPa
2	Water	2	S3	68.0 °C	S4	79.0 °C	8.00 m³/h	29.2 kPa

PLATE HEAT EXCHANGER  
T5-BFG

PRESSURE VESSEL APPROVAL PED



www.alfalaval.com

CUSTOMER NAME / REF. NO.

COMPANY / REF.  
IPC - Industrial Power Cooling Ltd  
ALPHE18/6951/MC - ORE SOLUTIONS

TOTAL LENGTH	447 mm
TOTAL WIDTH	245 mm
TOTAL HEIGHT	737 mm
WEIGHT WITH WATER	92.7 kg

RISKCATEGORY Article 4.3

DATE 9/4/2018  
REV 0